

early years

Sand Play



SCHOOL
PLAYGROUND
SPECIALISTS

Log Train

Product Dimensions - Engine
2000mm (L) 1170mm (W) 1420mm (H)
Product Dimensions - Carriages
1000mm (L) 1000mm (W) 600mm (H)

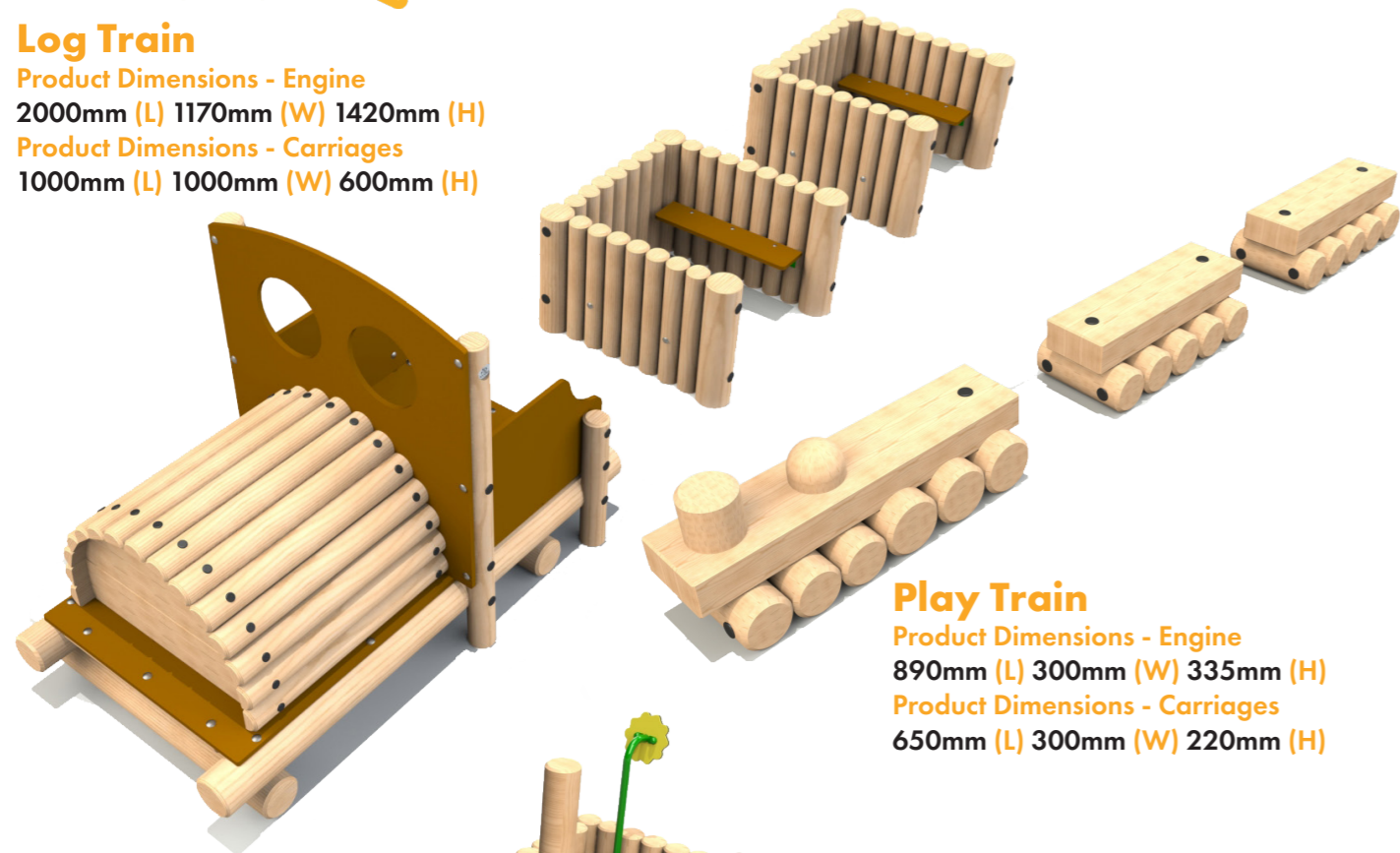

Play Train

Product Dimensions - Engine
890mm (L) 300mm (W) 335mm (H)
Product Dimensions - Carriages
650mm (L) 300mm (W) 220mm (H)

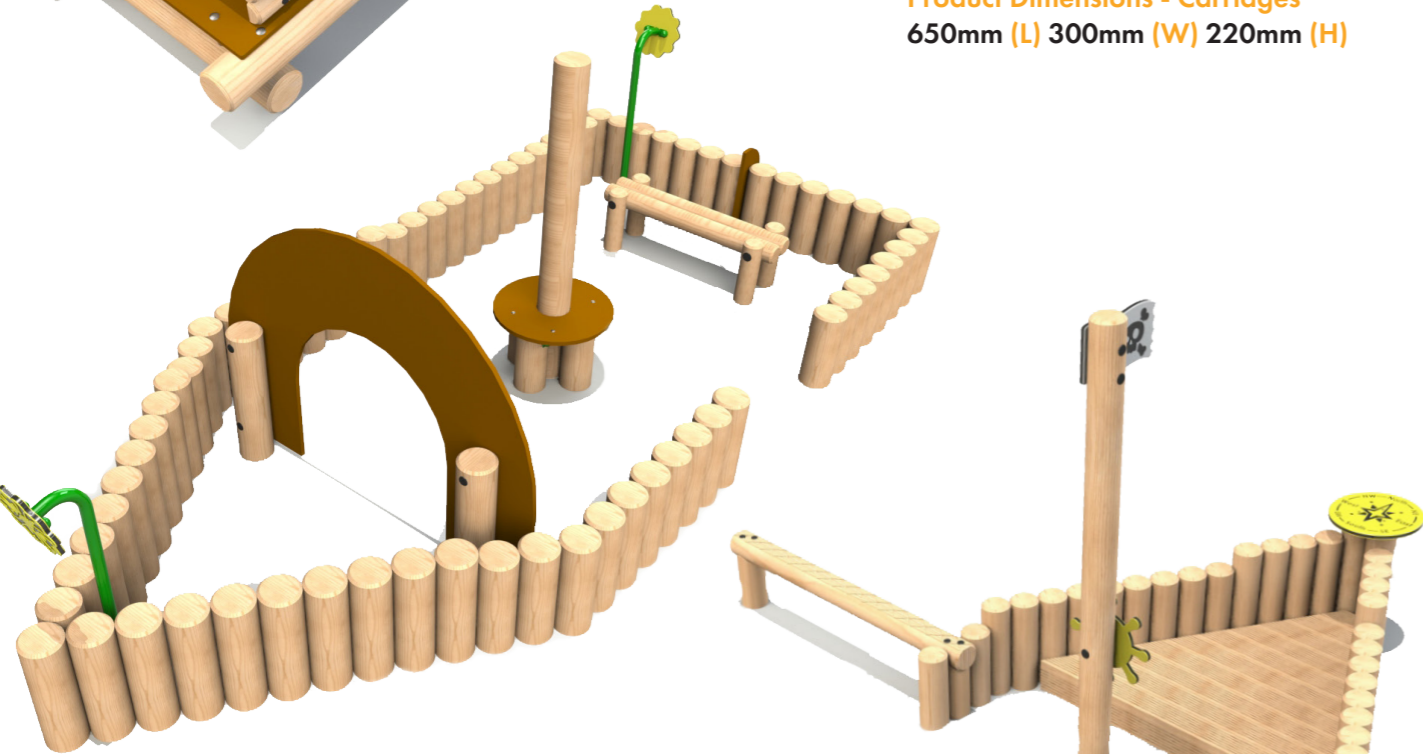

Tug Boat

Product Dimensions
4984mm (L) 2120mm (W) 1530mm (H)
(Includes 2 Way Talk Tubes)

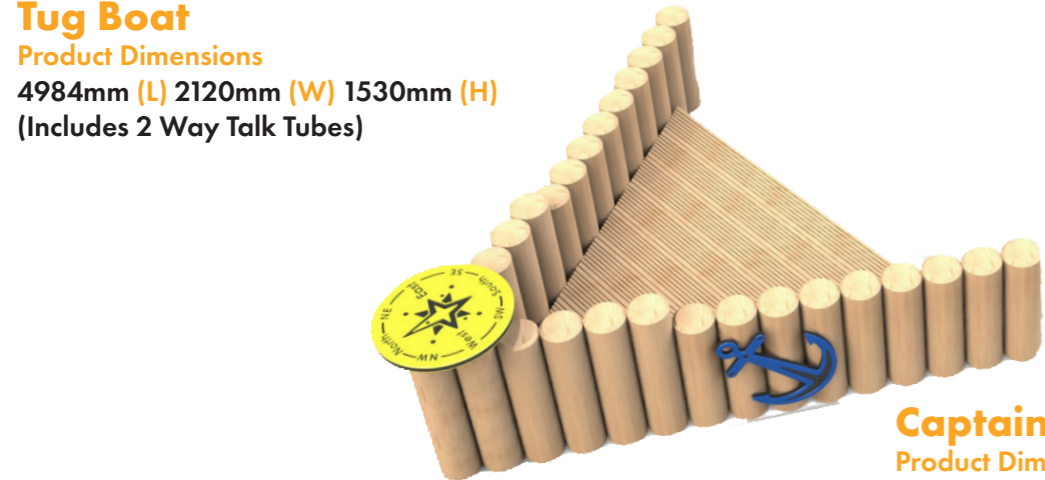

Captain's Boat

Product Dimensions
4990mm (L) 3238mm (W) 2000mm (H)

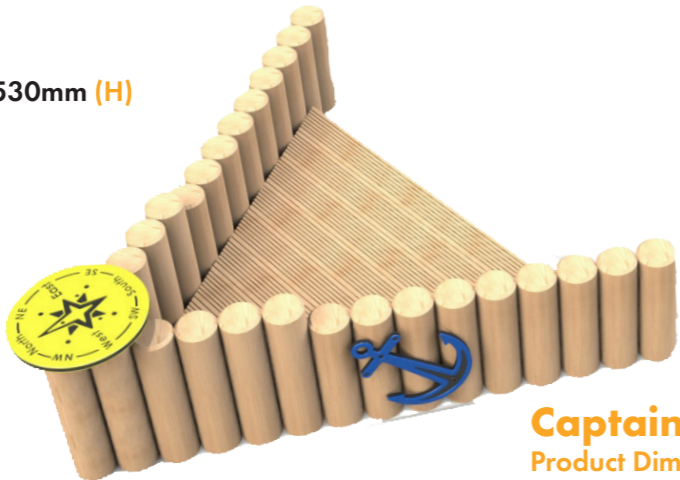

Bespoke options available, enquire for more information.

Sand Workshop Table

Product Dimensions
1500mm (L) 786mm (W) 675mm (H)
Sand Required: 0.07m³
(not Included)

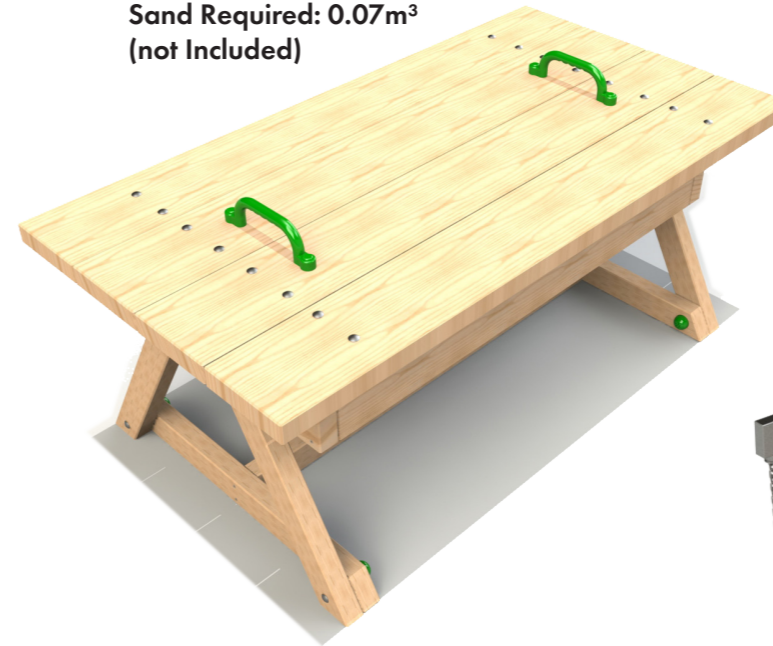

Sand Play Table

Product Dimensions
1020mm (L) 885mm (W) 650mm (H)
Sand Required: 0.089m³ (not Included)



Sleeper Sandpit

Product Dimensions
3000mm (L) 1500mm (W) 1850mm (H)
Sand Required: 1.12m³
(not Included)



Scales

Product Dimensions
780mm (L) 265mm (W) 1500mm (H)



Standard Sandpit

Product Dimensions
Open: 4260mm (L) 1220mm (W) 213mm (H)
Closed: 2400mm (L) 1220mm (W) 213mm (H)
Sand Required: 0.24m³ (not Included)

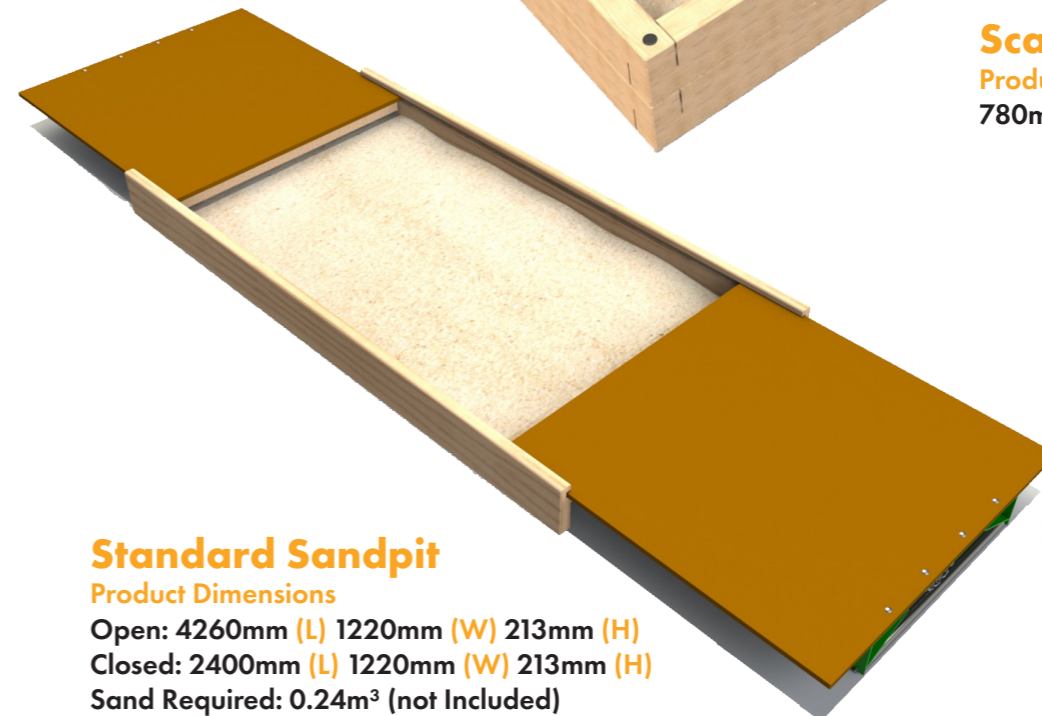

Steel feet options available upon request.

Outdoor Theatre

Product Dimensions
2520mm (L) 2100mm (W) 1820mm (H)
Bespoke engraving available on request

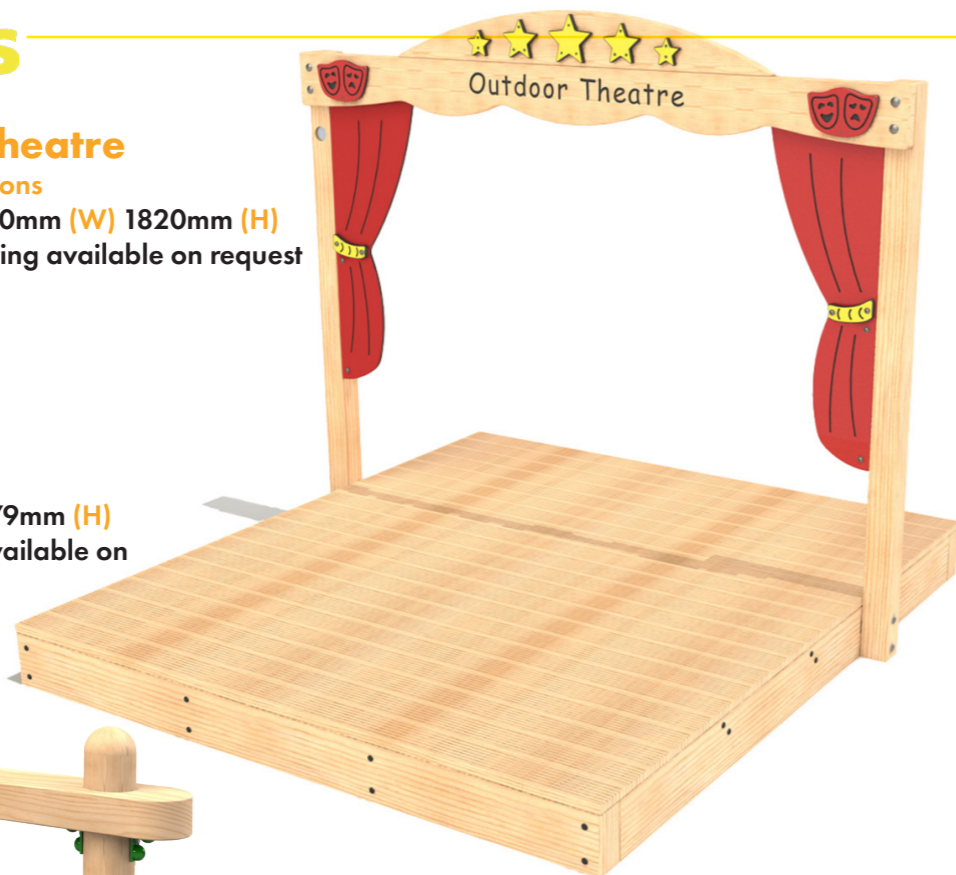

Friendship Bench

Product Dimensions
2200mm (L) 195mm (W) 1879mm (H)
Bespoke HDPE engraving available on request



1.95m Stage

Product Dimensions
1950mm (L) 1950mm (W) 146mm (H)
3.9m Stage also available

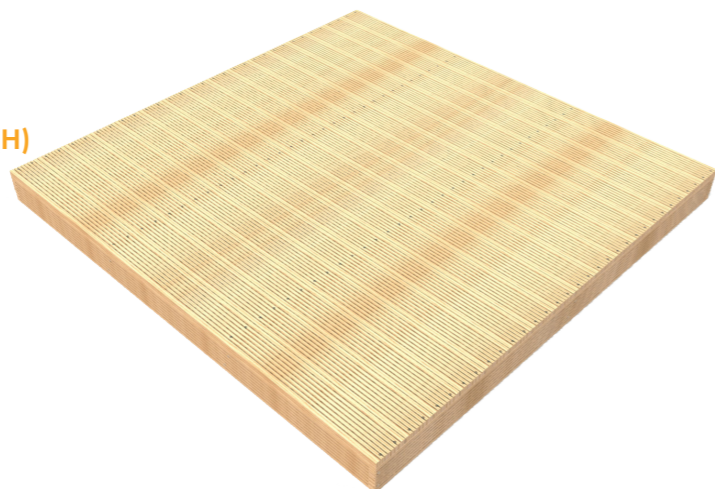

Enchantment Area

Once Upon a Time Chair x 1
Fairy Tale Button Stools x 15
1.8m Curved Sleeper Benches x 3

More Story Area designs can be found in the Story Time product range.

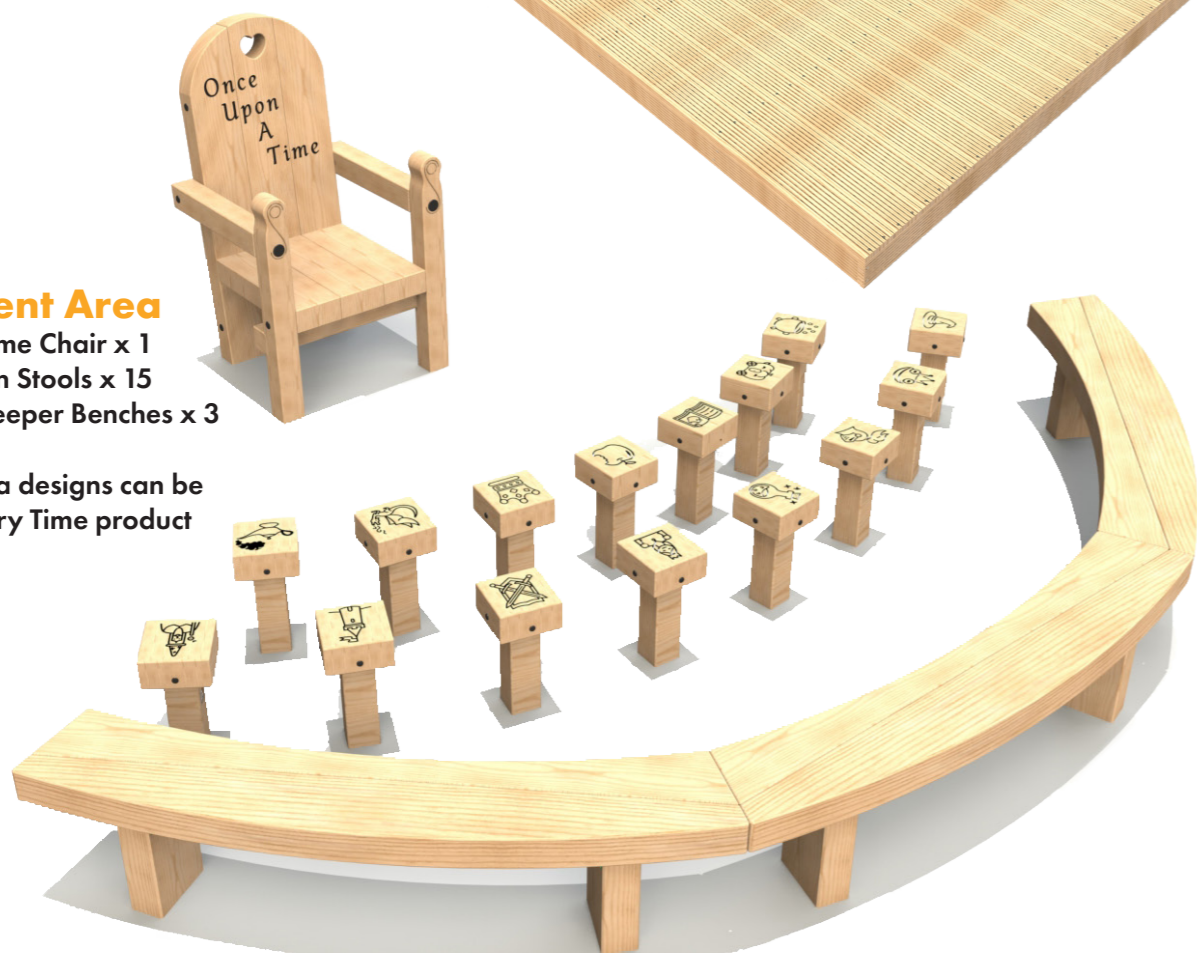

Bespoke options available, enquire for more information.

Wigwam

Product Dimensions
1950mm (L) 1950mm (W) 1308mm (H)
Bespoke HDPE engraving and colours available



Timber Tipi

Product Dimensions
2856mm (L) 2752mm (W) 1950mm (H)

Sleeper Tunnel with Steps

Product Dimensions
2400mm (L) 1390mm (W) 1700mm (H)
Minimum Surface Area: 20.34m²
5164mm (L) 4238mm (W)
Free Fall Height: 859mm

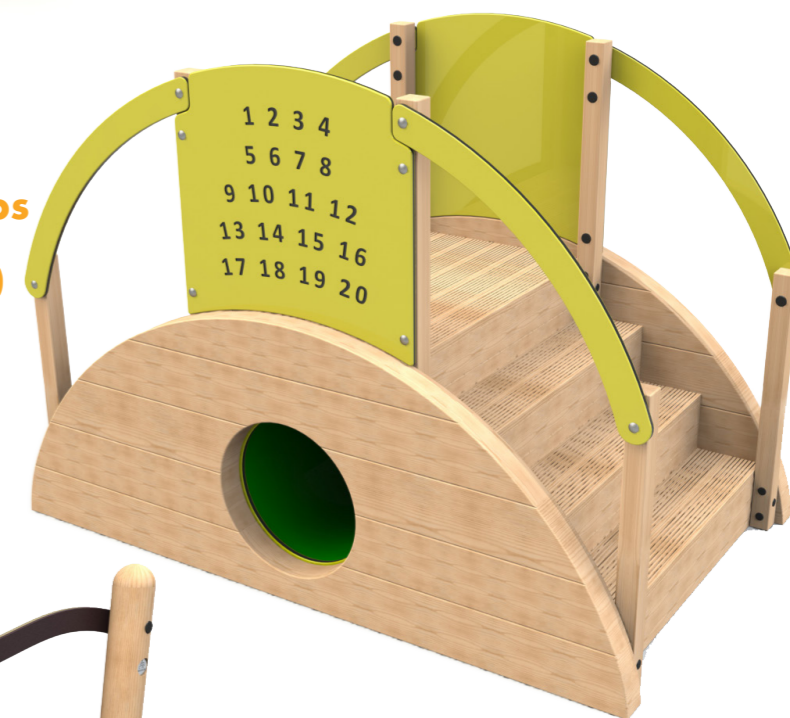

Wavy Bridge

Product Dimensions
2282mm (L) 1457mm (W) 1200mm (H)

More Timber Bridge designs can be found in the Stand Alone product range.

Steel feet options available upon request.

Animal Posts

Product Dimensions
280-462mm (L) 114mm (W) 1000mm (H)

35 Different UK animal designs available in a variety of different HDPE colours. More Animal Post designs can be found in the Stand Alone product range.



HDPE Play Panels

Product Dimensions
1050mm (L) 125mm (W) 1190mm (H)

HDPE Play Panels available with timber legs or as panels only. Available in a variety of colours.



Talk Tubes

Product Dimensions
1100mm (H)

Available in 2 and 3 way configurations, connected via 6m of plastic tubing 200mm below ground.



Seasonal Totem Poles

Product Dimensions
195mm (L) 95mm (W) 1500mm (H)

The seasonal totem poles contain playful references to each season of the year.

- Spring
- Summer
- Autumn
- Winter



Nursery Rhyme Totem Poles

Product Dimensions
195mm (L) 95mm (W) 1500mm (H)

Each totem pole contains a nursery rhyme with icons.

- Hey Diddle Diddle
- Humpty Dumpty
- Incy Wincy Spider
- Twinkle Twinkle



Play Time Totem Poles

Product Dimensions
195mm (L) 95mm (W) 1500mm (H)

Each totem pole brings a new dimension of educational play to a playground.

- Height and Hands
- Finger Maze Madness
- Minibeast Manor
- Treasure Map

All totem poles are sold individually but can be purchased as a group.



Mountain Range Play Scene

Product Dimensions (Suggested Layout)
3900mm (L) 760mm (W) 1490mm (H)

Includes 6 Individual Sections with HDPE Panels



Galleon Play Scene

Product Dimensions (Suggested Layout)
3977mm (L) 1000mm (W) 2100mm (H)

Includes 5 Individual Sections with HDPE Panels

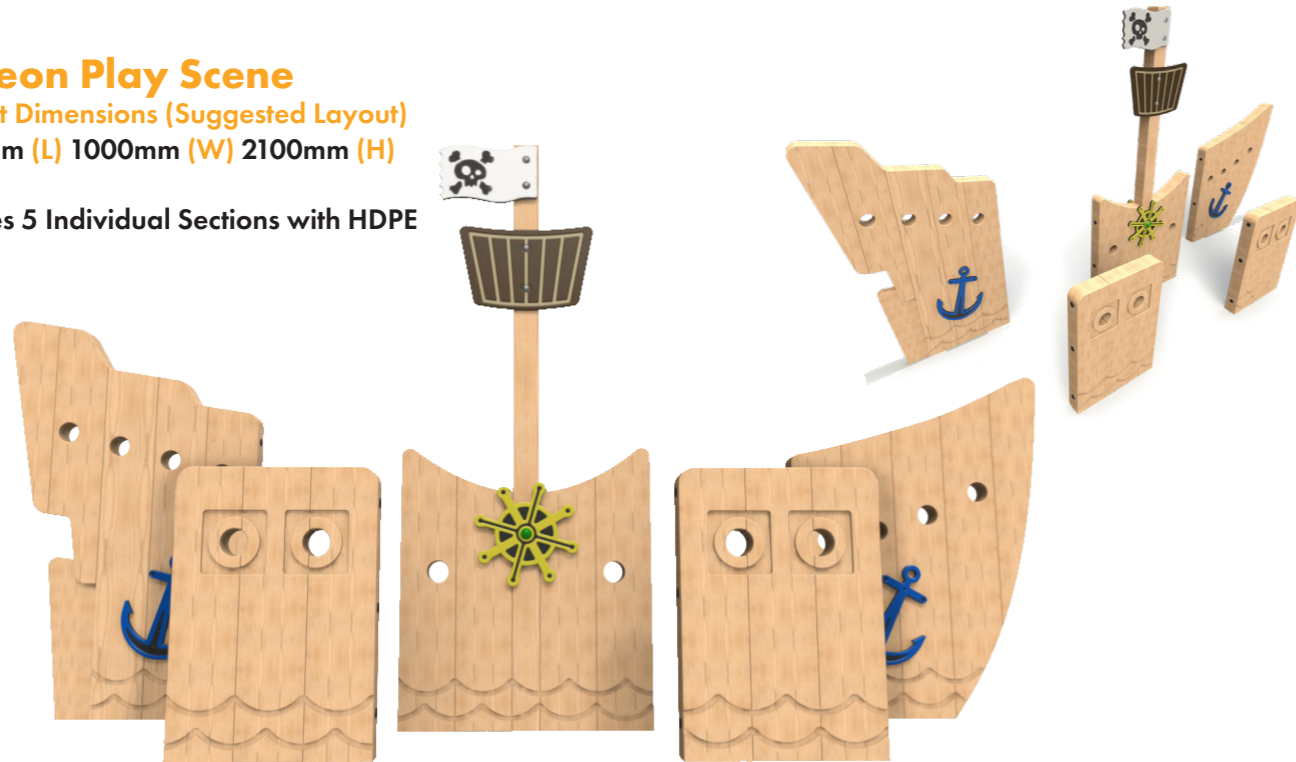

Castle Play Scene

Product Dimensions (Suggested Layout)
3310mm (L) 1085mm (W) 2000mm (H)

Includes 5 Individual Sections with HDPE Panels



Bespoke options available, enquire for more information.

Castle Slide Unit

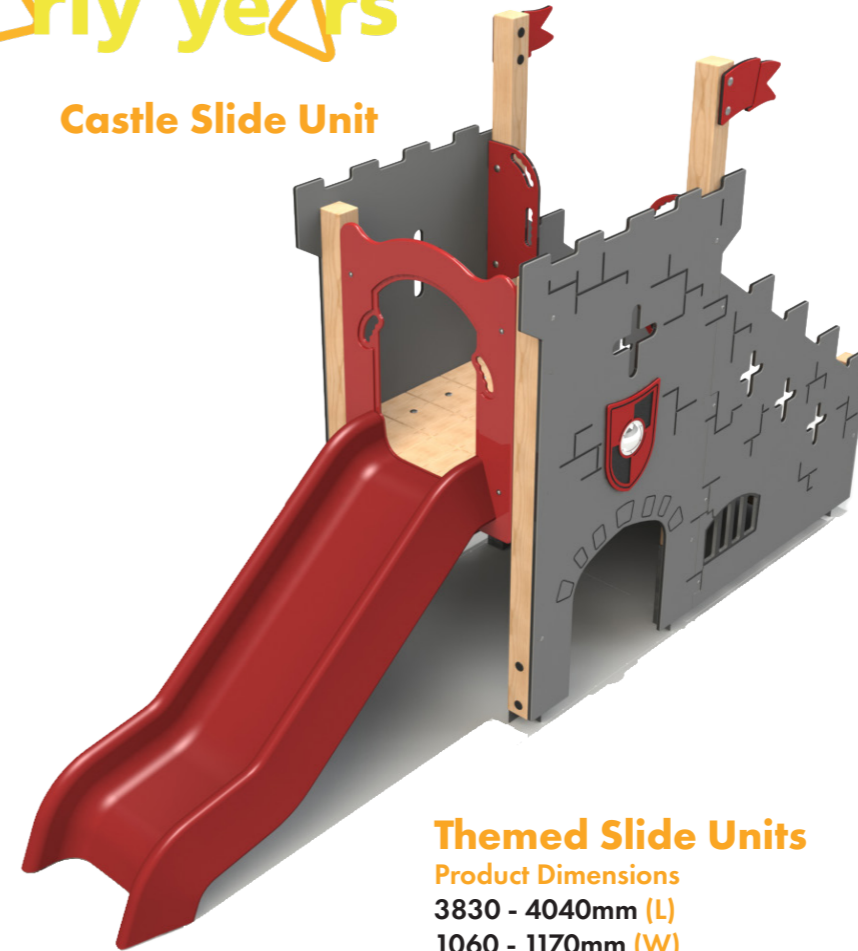

Fire Engine Slide Unit



Dump Truck Slide Unit

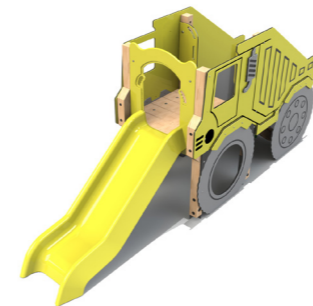

Elephant Slide Unit

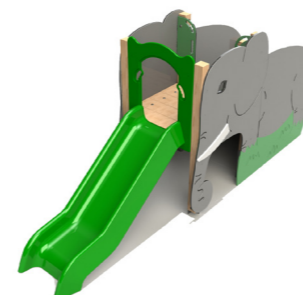

Submarine Slide Unit

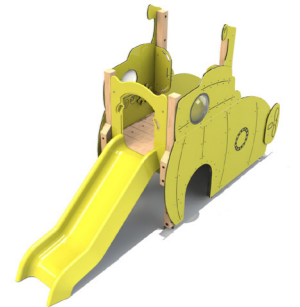

Rocket Slide Unit

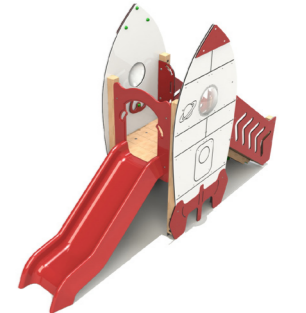

Whale Slide Unit



Themed Slide Units

Product Dimensions
3830 - 4040mm (L)
1060 - 1170mm (W)
1730 - 2460mm (H)
Minimum Surface Area: 24.5m²
7160mm (L) 3990mm (W)
Free Fall Height: 900mm

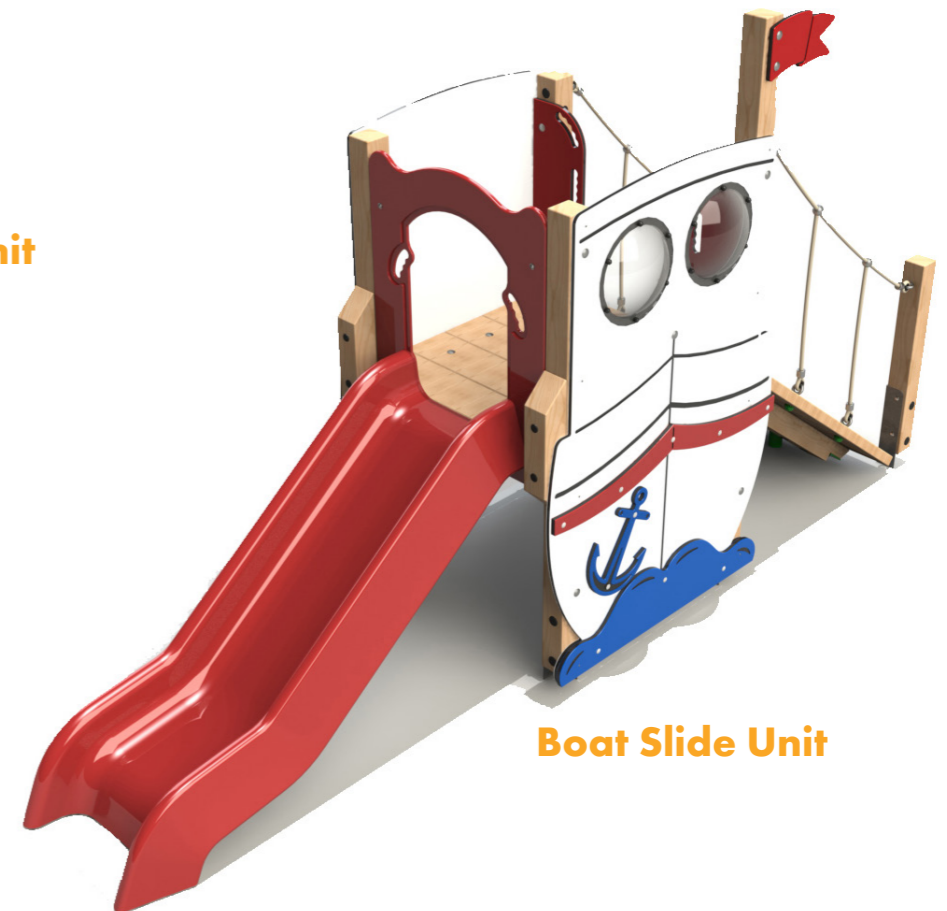

Boat Slide Unit

Steel feet options available upon request.

House of Fun

Product Dimensions
2904mm (L) 1190mm (W) 2110mm (H)

- Features
- HDPE Shop Panel with Counter
 - 2 x Noughts & Crosses Panels
 - Splash Panel
 - Timber Bench
 - Timber Roof



Cygnet

Product Dimensions
3312mm (L) 2595mm (W) 1185mm (H)
Minimum Surface Area: 29.27m²
6360mm (L) 5593mm (W)
Free Fall Height: 579mm



Cygnet with Plastic Slide

Product Dimensions
3617mm (L) 2810mm (W) 1470mm (H)
Minimum Surface Area: 31.66m²
7010mm (L) 5810mm (W)
Free Fall Height: 585mm



Bespoke options available, enquire for more information.

Single Deck Unit 01

Product Dimensions
3411mm (L) 1018mm (W) 1845mm (H)
Minimum Surface Area: 23.52m²
6878mm (L) 4018mm (W)
Free Fall Height: 900mm

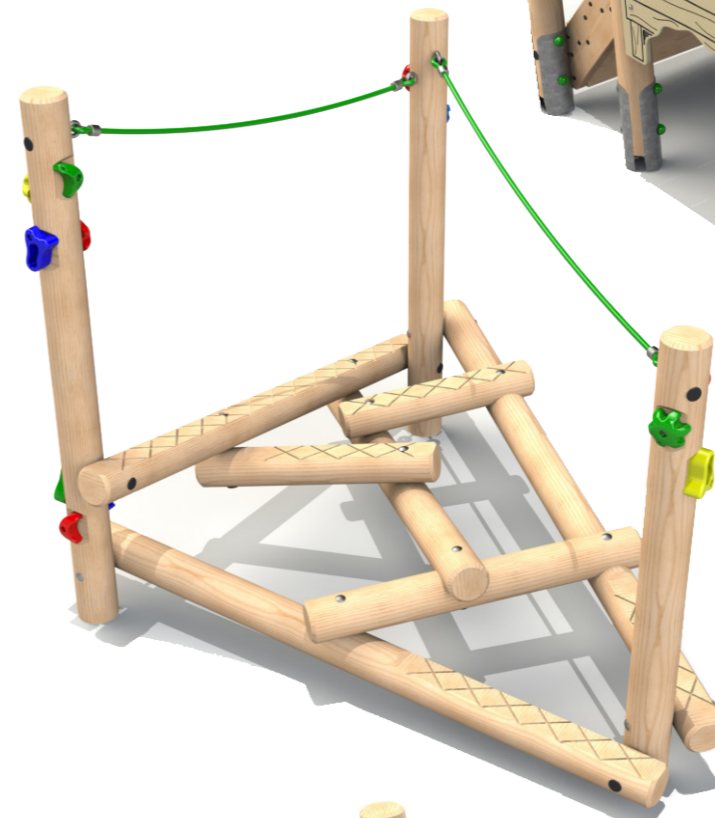

Clamber Stack Piccolo with Ropes

Product Dimensions
2030mm (L) 1810mm (W) 1675mm (H)
Minimum Surface Area: 19.24m²
5116mm (L) 4853mm (W)
Free Fall Height: 599mm

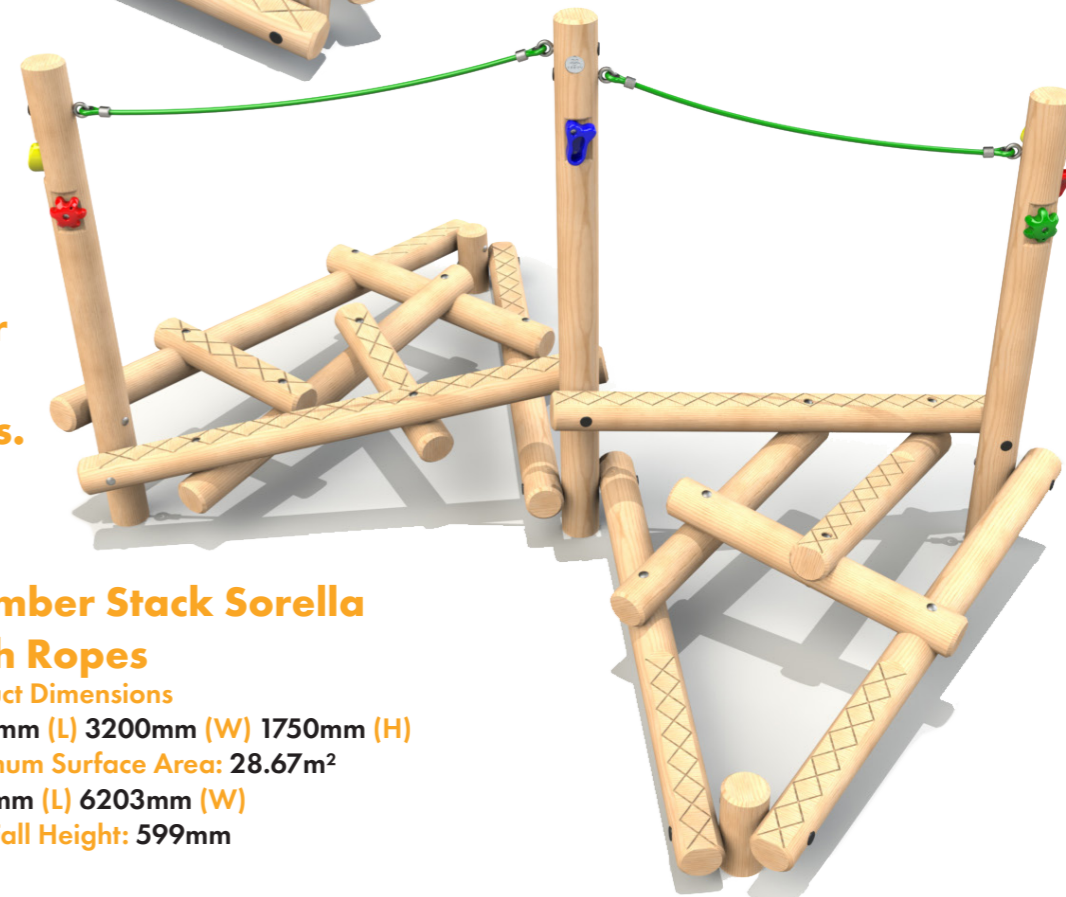

See our Clamber Stacks brochure for more designs.

Clamber Stack Sorella with Ropes

Product Dimensions
3620mm (L) 3200mm (W) 1750mm (H)
Minimum Surface Area: 28.67m²
6619mm (L) 6203mm (W)
Free Fall Height: 599mm

Steel feet options available upon request.

See our Timber Towers brochure for more designs.



early years

The ability to offer unrivalled value for money whilst still ensuring exceptional quality and longevity is key. The Early Years range accommodates all budgets and play scheme sizes.

Our uncompromising approach to safety during the design and manufacturing process is paramount. With this in mind the Early Years range is designed to meet the requirements of BS EN 1176.

In order to ensure the highest level of accuracy, all units are produced on our custom made, state of the art, 6 Axis CNC machine. This technology allows us to offer unparalleled accuracy in the field of play timber production.



**SCHOOL
PLAYGROUND
SPECIALISTS**

Tel: 01244 267685

www.schoolplaygroundspecialists.co.uk

Email: info@schoolplaygroundspecialists.co.uk

Vickers Way,
Broughton, Chester,
CH4 0FX